

Integracja
społeczna

Atrakcja dla
wszystkich

Aktywność
fizyczna

LINARIA



ARC01

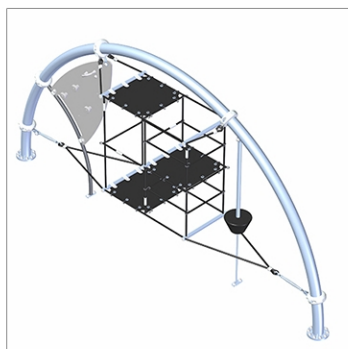

ARC02

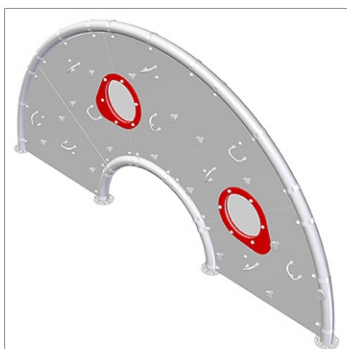

ARC03



ARC04

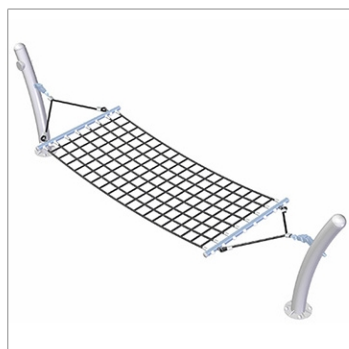

ARC05



ARC06 / R06D



ARC07

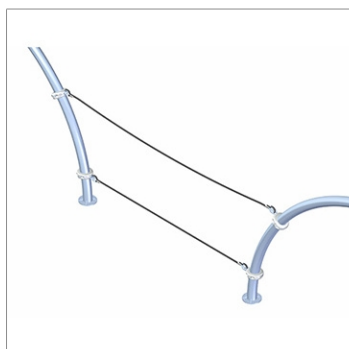

ARC08

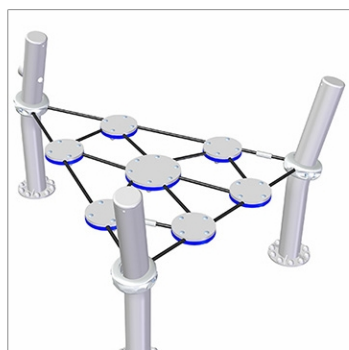

ARC09

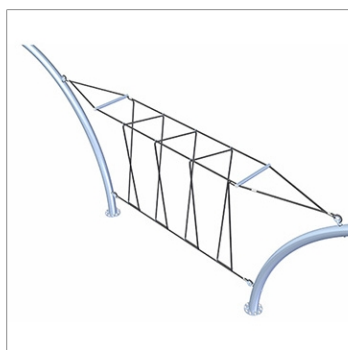

ARC10



ARC12



DOM03

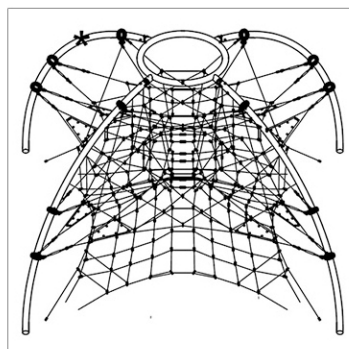

L18

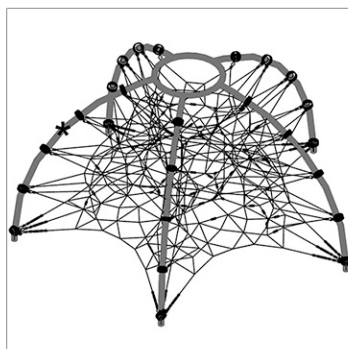

DOM05

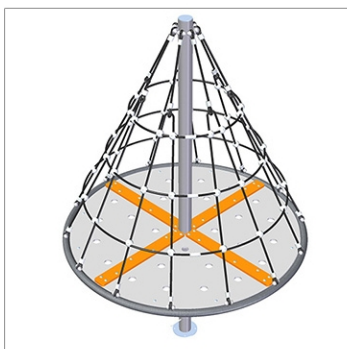

L31

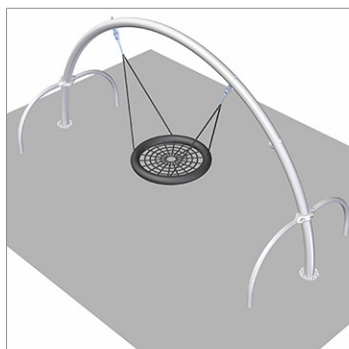

L32

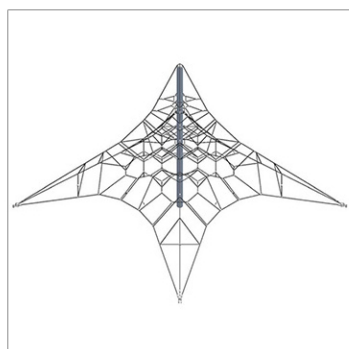

R04

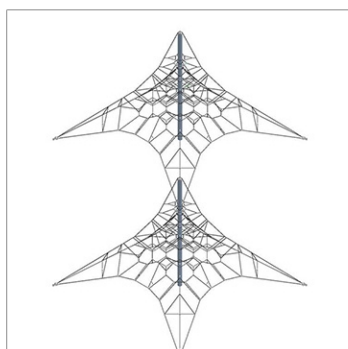

R04D

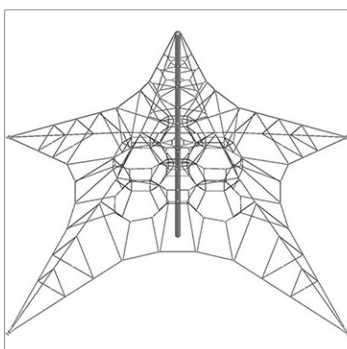

R06

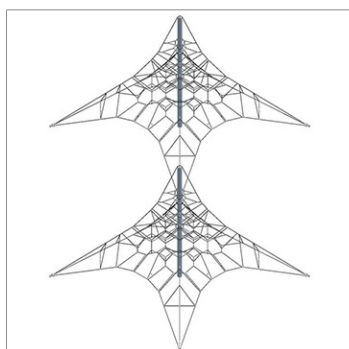

R06D