

Bezpieczne

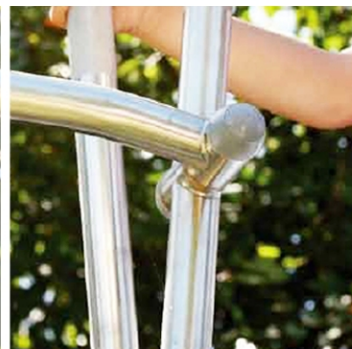

Certyfikowane



Nowoczesne  
wzornictwo

Gwarancja  
najwyższej  
jakości



PAC001



PAC002

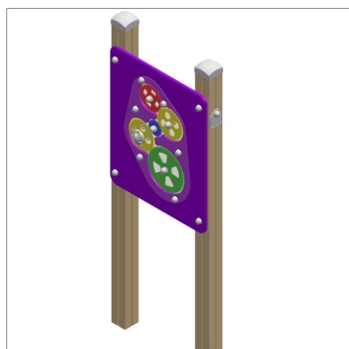

PAC003



PAC004



PAC006

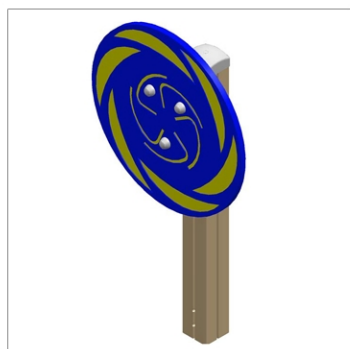

PAC012

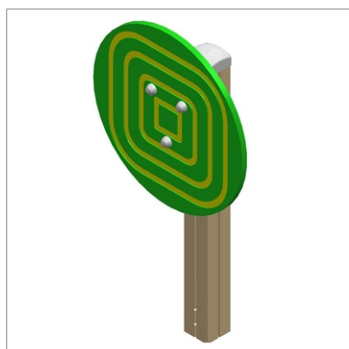

PAC013

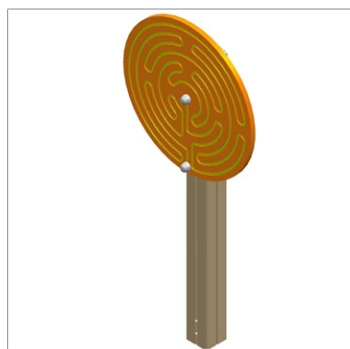

PAC014

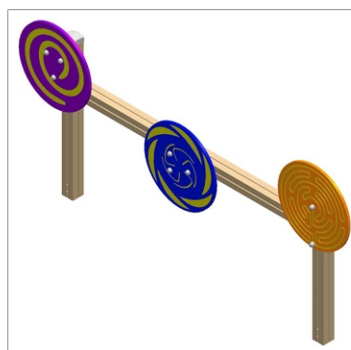

PAC015

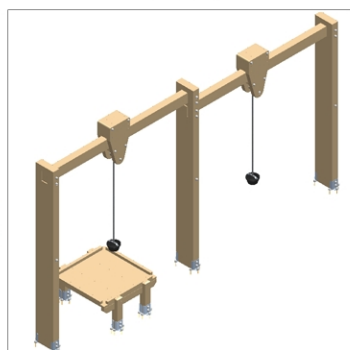

RA02



TORARQ



VAM01

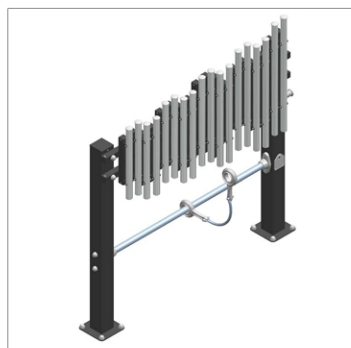

XIL

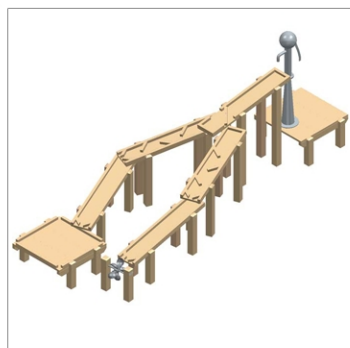

AQUA01

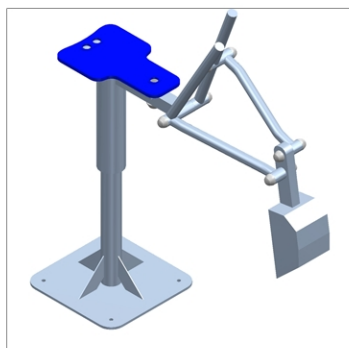

F310

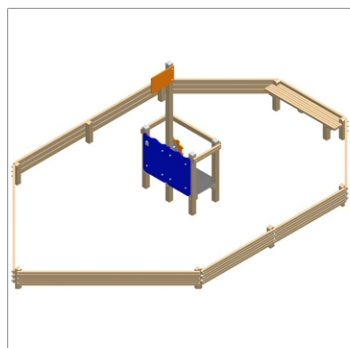

F500



MOLAGUA

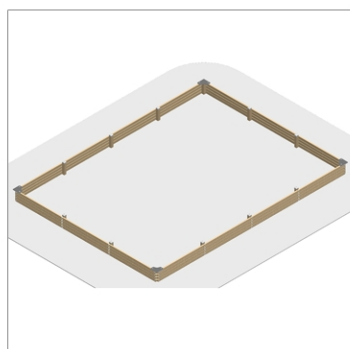

F100A

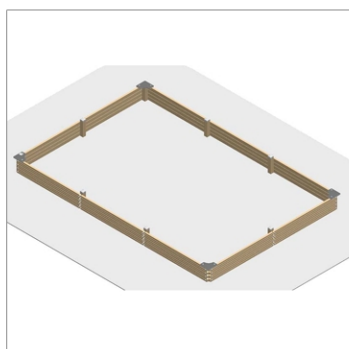

F100B

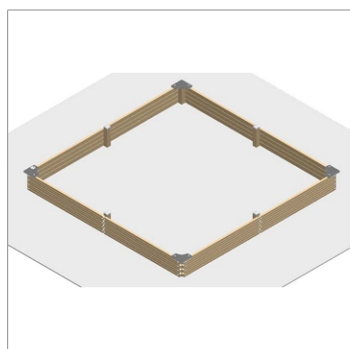

F100C